

WEATHER BREAKER 175

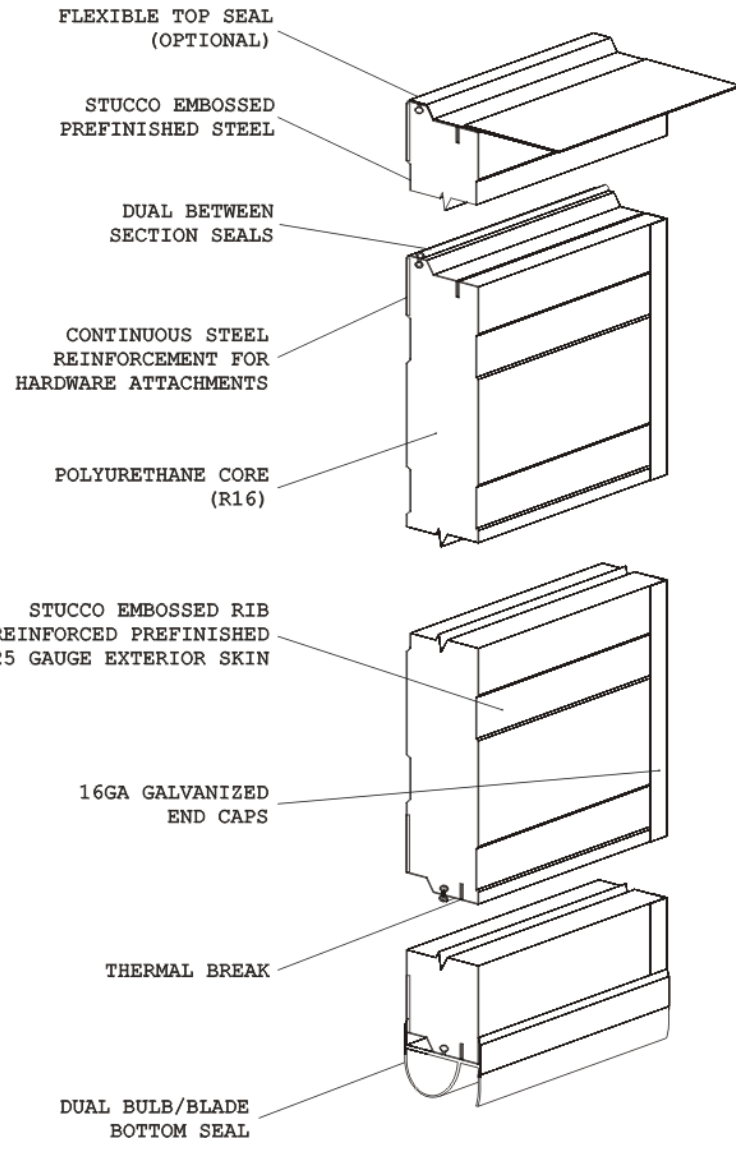

EXTERIOR ELEVATION

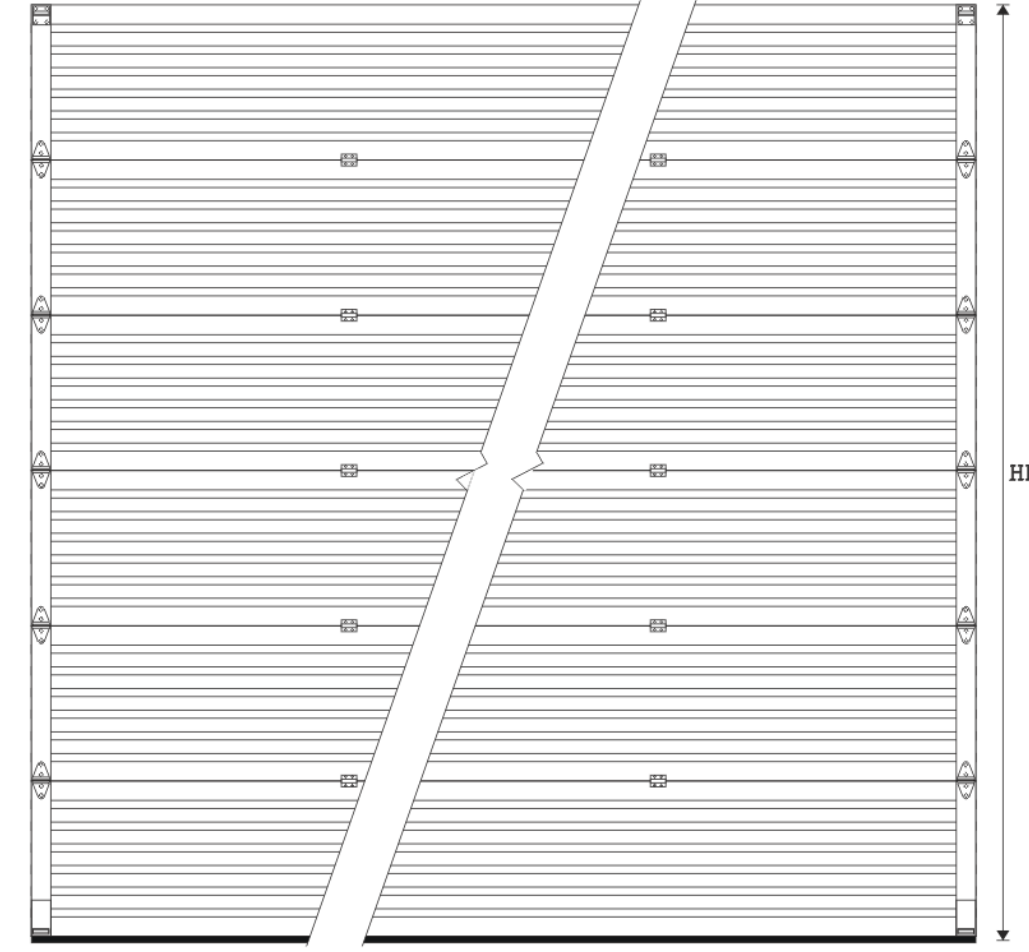

INTERIOR ELEVATION

WIDTH

HEIGHT

NOTES:

LITE OPTIONS



DWG #	DOOR NUMBER	QTY	OPENING SIZE		DOOR SIZE		SECTIONS HIGH	PANELS WIDE	EXTERIOR COLOR	HEAD SEAL	# OF LITES	LITE SIZE	LOCK TYPE
			WIDTH	HEIGHT	WIDTH	HEIGHT							
JOB:													
CONTR:													
DISTR:													
ARCH:													

